



OM 3418

COFFRET EXTRACTION ROULEMENTS PRISE INTERIEURE  
Ø8-Ø58mm





BEARING EXTRACTOR SET INTERNAL GRIP  
Ø8-58mm



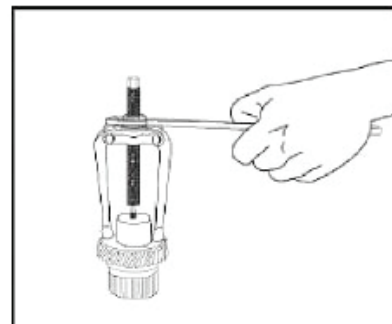
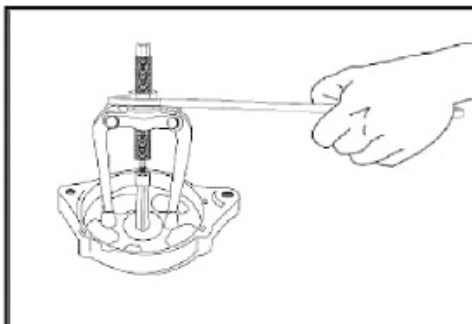
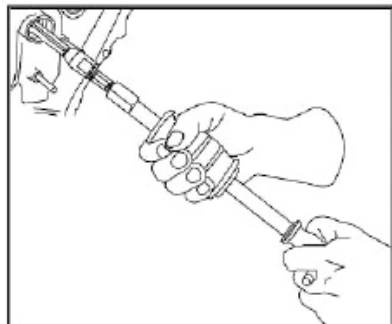

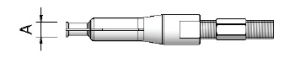
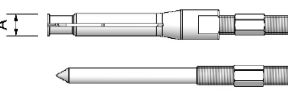
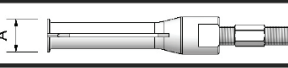
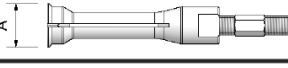
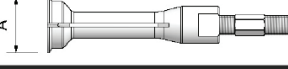
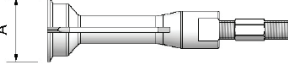
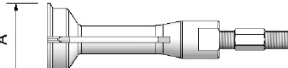
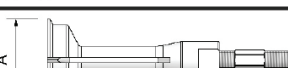
CARACTERISTIQUES

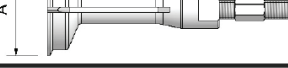
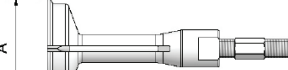









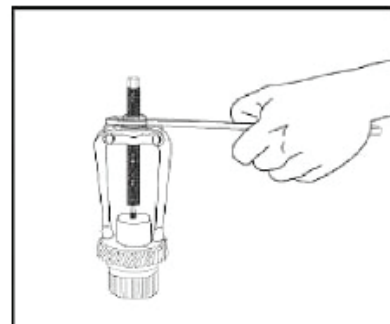
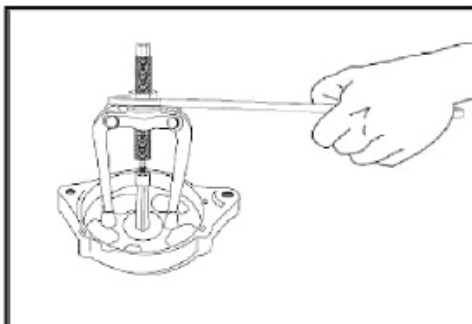
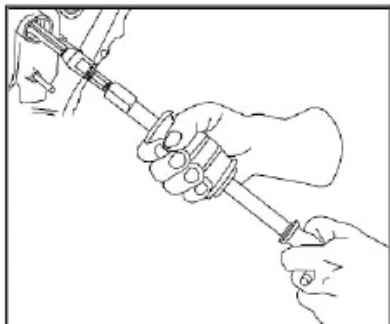

DESCRIPTION	TAILLE	
	min A max 8mm ~ 11mm	
	min A max 12mm ~ 17mm	
	min A max 18mm ~ 23mm	
	min A max 24mm ~ 29mm	
	min A max 30mm ~ 34mm	
	min A max 34mm ~ 38mm	
	min A max 39mm ~ 43mm	
	min A max 44mm ~ 48mm	
	min A max 49mm ~ 53mm	
	min A max 54mm ~ 58mm	
	A size	M10 x 1.5P
	B size	
	A size	M10 x 1.5P
	B size	M8 x 1.25P
	A size	M10 x 1.5P
	B size	M6 x 1.0P

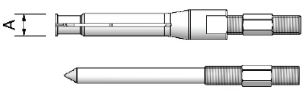
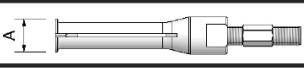

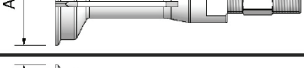
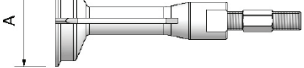
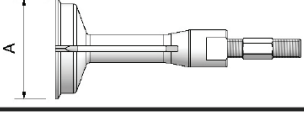

CHARACTERISTICS



INDICATE 	RANGE	
	min A max 8mm ~ 11mm	
	min A max 12mm ~ 17mm	
	min A max 18mm ~ 23mm	
	min A max 24mm ~ 29mm	
	min A max 30mm ~ 34mm	
	min A max 34mm ~ 38mm	
	min A max 39mm ~ 43mm	
	min A max 44mm ~ 48mm	
	min A max 49mm ~ 53mm	
	min A max 54mm ~ 58mm	
	A size	M10 x 1.5P
	B size	
	A size	M10 x 1.5P
	B size	M8 x 1.25P
	A size	M10 x 1.5P
	B size	M6 x 1.0P





**CLAS EQUIPEMENTS**

ZA de la CROUZA  
73800 CHIGNIN  
FRANCE

Tél. +33 (0)4 79 72 62 22

Fax. +33 (0)4 79 72 52 86

**OM 3418**

**COFFRET EXTRACTION ROULEMENTS  
PRISE INTERIEURE Ø8-Ø58mm**

**BEARING EXTRACTOR SET INTERNAL GRIP Ø8-58mm**

---

Si vous avez besoin de composants ou de pièces, contactez le revendeur  
En cas de problème veuillez contacter le technicien de votre distributeur agréé

---

If you need components or parts, please contact the reseller.  
In case of problems, please contact your authorized technician.